

PTAC/PTHP

SERIES

PACKAGED TERMINAL AIR CONDITIONER / HEAT PUMP

SERVICE MANUAL

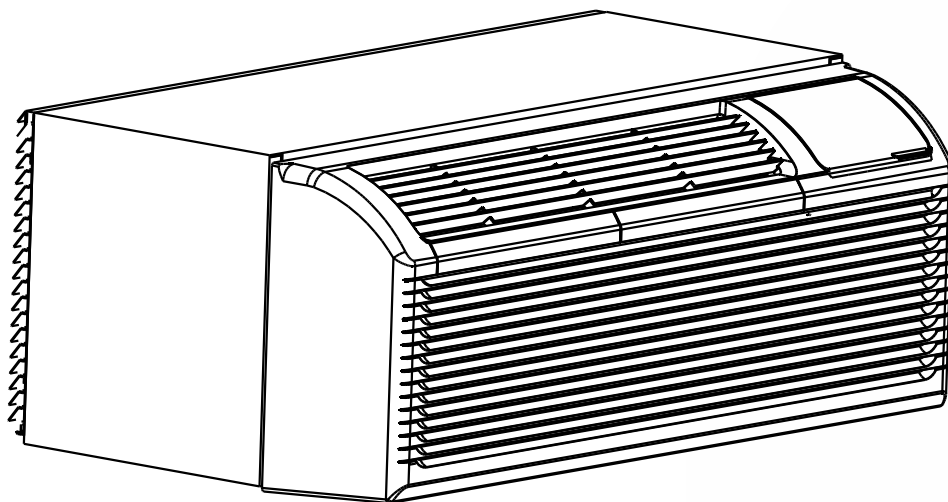

KLIMAIRE[®] ≈
Mark of Superior Quality

IMPORTANT NOTE:
Read this manual carefully before installing
or operating your new air conditioning
unit. Make sure to save this manual for
future reference.

For more information please visit www.klimaier.com

CONTENTS

1. Precaution	P1-4
1.1 Safety Precaution	P1
1.2 Warning	P1-4
2. Functions and control panel.	P5-7
3. Dimension	P8
4. Wiring Diagram	P9
5. Refrigerant Cycle Diagram	P10
6. Electronic function	P11-19
6.1 Terms and definitions	P11
6.2 Electric Control working environment	P11
6.3 Protection function	P11
6.4 Fan only mode	P11
6.5 Cooling mode	P11
6.6 Heating mode	P12-14
6.7 Dip switches Configurations (Optional)	P14-15
6.8 DIP Switches Configurations by Panel Control (Optional)	P16-19
7. Unit components	P19-20
8. Installation details	P20-23
8.1 How to install the unit	P20-22
8.2 Care and cleaning	P22-23
9. Operation characteristics	P24
9.1 Cooling operation	P24
9.2 Heating operation	P24
10. Power connection options	P25-26
11. Troubleshooting	P27-32

1. Precaution

1.1 Safety Precaution.

- To prevent injury to the user or other people and property damage, the following instructions must be followed.

Incorrect operation due to ignoring instruction will cause harm or damage.

Before service unit, be sure to read this service manual at first.

1.2 Warning

INSTALLATION

- Do not use a defective or underrated circuit breaker. Use this appliance on a dedicated circuit.

There is risk of fire or electric shock.

- For electrical work, contact the dealer, seller, a qualified electrician, or an Authorized service center.

Do not disassemble or repair the product, there is risk of fire or electric shock.

- Always ground the product.

There is risk of fire or electric shock.

- Install the panel and the cover of control box securely.

There is risk of fire of electric shock.

- Always install a dedicated circuit and breaker.

Improper wiring or installation may cause fire or electric shock.

- Use the correctly rated breaker of fuse.

There is risk of fire or electric shock.

- Do not modify or extend the power cab

There is risk of fire or electric shock.

- Do not install, remove, or reinstall the unit by yourself(customer).

There is risk of fire, electric shock, explosion, or injury.

- Be caution when unpacking and installing the product.

Sharp edges could cause injury, be especially careful of the case edges and the fins on the condenser and evaporator.

- For installation, always contact the dealer or an Authorized service center.

There is risk of fire, electric shock, explosion, or injury.

- Do not install the product on a defective installation stand.

It may cause injury, accident, or damage to the product.

- Be sure the installation area does not deteriorate with age.

If the base collapses, the air conditioner could fall with it, causing property damage, product failure, and personal injury.

- Do not let the air conditioner run for a long time when the humidity is very high and a door or a window is left open.

Moisture may condense and wet or damage furniture.

- Take care to ensure that power cable could not be pulled out or damaged during operation.

There is risk of fire or electric shock.

- Do not place anything on the power cable.

There is risk of fire or electric shock.

- Do not plug or unplug the power supply plug during operation.

There is risk of fire or electric shock.

- Do not touch (operation) the product with wet hands.

There is risk of fire or electric shock.

- Do not place a heater or other appliance near the power cable.

There is risk of fire and electric shock.

- Do not allow water to run into electric parts.

It may cause fire, failure of the product, or electric shock.

- Do not store or use flammable gas or combustible near the product.

There is risk of fire or failure of product.

- Do not use the product in a tightly closed space for a long time.

Oxygen deficiency could occur.

- When flammable gas leaks, turn off the gas and open a window for ventilation before turn the product on.

Do not use the telephone or turn switches on or off. There is risk of explosion or fire.

- If strange sounds, or smell or smoke comes from product. Turn the breaker off or disconnect the power supply cable.

There is risk of electric shock or fire.

- Stop operation and close the window in storm or hurricane. If possible, remove the product from the window before the hurricane arrives.

There is risk of property damage, failure of product, or electric shock.

- Do not open the inlet grill of the product during operation.

(Do not touch the electrostatic filter, if the unit is so equipped.)

There is risk of physical injury, electric shock, or product failure.

- When the product is soaked (flooded or submerged), contact an Authorized service center.

There is risk of fire or electric shock.

- Be caution that water could not enter the product.

There is risk of fire, electric shock, or product damage.

- Ventilate the product from time to time when operating it together with a stove, etc.

There is risk of fire or electric shock.

- Turn the main power off when cleaning or maintaining the product.

There is risk of electric shock.

- When the product is not be used for a long time, disconnect the power supply plug or turn off the breaker.

There is risk of product damage or failure, or unintended operation.

- Take care to ensure that nobody could step on or fall onto the outdoor unit.

This could result in personal injury and product damage.

CAUTION

- Always check for gas (refrigerant) leakage after installation or repair of product.

Low refrigerant levels may cause failure of product.

- Install the drain hose to ensure that water is drained away properly.

A bad connection may cause water leakage.

- Keep level even when installing the product.

To avoid vibration of water leakage.

- Do not install the product where the noise or hot air from the outdoor unit could damage the neighborhoods.

It may cause a problem for your neighbors.

- Use two or more people to lift and transport the product.

Avoid personal injury.

- Do not install the product where it will be exposed to sea wind (salt spray) directly.

It may cause corrosion on the product. Corrosion, particularly on the condenser and evaporator fins, could cause product malfunction or inefficient operation.

- Do not expose the skin directly to cool air for long periods of time.

(Do not sit in the draft).

This could harm to your health.

- Do not use the product for special purposes, such as preserving foods, works of art, etc. It

is a consumer air conditioner, not a precision refrigerant system

There is risk of damage or loss of property.

- Do not block the inlet or outlet of air flow.

It may cause product failure.

- Use a soft cloth to clean. Do not use harsh detergents, solvents, etc.

There is risk of fire, electric shock, or damage to the plastic parts of the product.

- Do not touch the metal parts of the product when removing the air filter. They are very sharp.

There is risk of personal injury.

- Always insert the filter securely. Clean the filter every two weeks or more often if necessary.

A dirty filter reduces the efficiency of the air conditioner and could cause product malfunction or damage.

- Do not insert hands or other object through air inlet or outlet while the product is operated.

There are sharp and moving parts that could cause personal injury.

- Do not drink the water drained from the product.

It is not sanitary could cause serious health issues.

- Use a firm stool or ladder when cleaning or maintaining the product.

Be careful and avoid personal injury.

- Replace the all batteries in the remote control with new ones of the same type. Do not mix old and new batteries or different types of batteries.

There is risk of fire or explosion.

- Do not recharge or disassemble the batteries. Do not dispose of batteries in a fire.

They may burn or explode.

- If the liquid from the batteries gets onto your skin or clothes, wash it well with clean water.

Do not use the remote of the batteries have leaked.

The chemical in batteries could cause burns or other health hazards.

2. Functions and control panel.

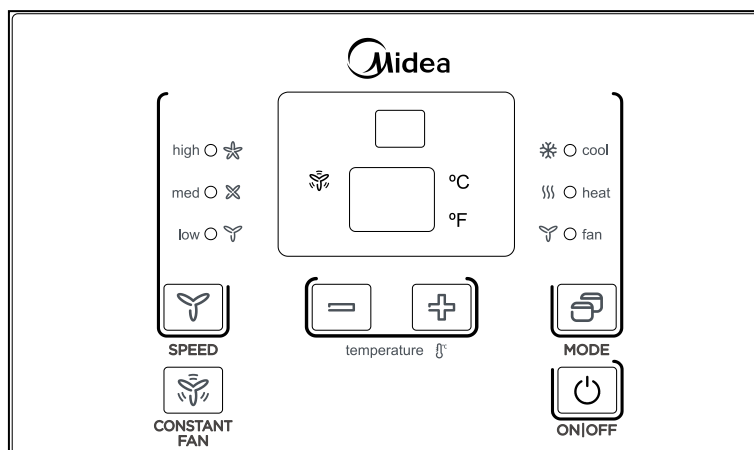

The controls featured in this manual are representative of many available models. Your model may offer slightly different features.

·POWER

- Press the POWER button to turn the unit on or off.

·MODE

- Push this button to cycle through the modes from COOL-HEAT-FAN-COOL. The indicator light beside the "MODE" option will illuminate, identifying the mode selected.

- COOL: The range of set temperature is 17°C/62°F ~30°C/86°F. Cooling begins automatically when the room temperature is above the set point, and stops when the room temperature is 2°C (4°F) below the set point. But the compressor will run 5 minutes at least in COOL mode before stopping.

- HEAT: The range of set temperature is 17°C/62°F ~29°C/84°F. For heat pump models, the unit can alternate to run between in reverse cycle heat mode and electric heater mode according to the difference between the setting temperature and the room temperature. The fan motor cycles with the compressor stop.

NOTE: The reverse cycle and electric heater cannot be run at the same time. In following cases, it is normal that the reverse cycle does not operate.

1. When the outdoor temperature is lower than 4°C/40°F or the room temperature falls to 4.5°C/8°F below the set point temperature.

2. There is a 3-minute minimum compressor run time at any setting to prevent short cycling. The indoor fan motors starts before the compressor and stops after the compressor cycles off.

3. Push the S1 on the DIP SWITCHES to UP (ON) position

4. When frost builds up to the evaporator coils, the unit will defrost automatically and the compressor will cycle off.

- FAN: Fan operation only without heating and cooling.

·UP/DOWN BUTTONS (+ / -)

- Push the UP (or DOWN) button to increase (or decrease) the set temperature of the unit in cooling or heating mode. The temperature can be set by increments of 1°C (1°F).The setting temperature appears in the display.

NOTE: Press and hold + and - buttons together for 3 seconds will alternate the temperature display between °C & °F scale.

·FAN (FAN SPEED)

- Every time you push this button, the fan speed cycles through the settings as follows: HIGH-MED- LOW-HIGH.

·CONSTANT FAN

-In cooling mode, press the button to turn on or off the constant fan function. When the function is turned on, the constant fan light will illuminate, identifying the fan continuous run for cooling. When the function is turned off, the constant fan light will go out, identifying the fan cycle run with compressor stop.

·DISPLAYS:

- Shows the set temperature in °C or °F. While on Fan only mode, it shows the room temperature.

Control code:

LC-Pads on the control panel is not available. The unit can be set by using wire controller only.

Note: When receiving the wired remote control signal display LC. Or when wired remote control signal is not received within the panel key operation for 5 seconds to display LC

FC-Pads on the control panel and wire controller are not available. The unit can be set by using FRONT DESK CONTROL only.

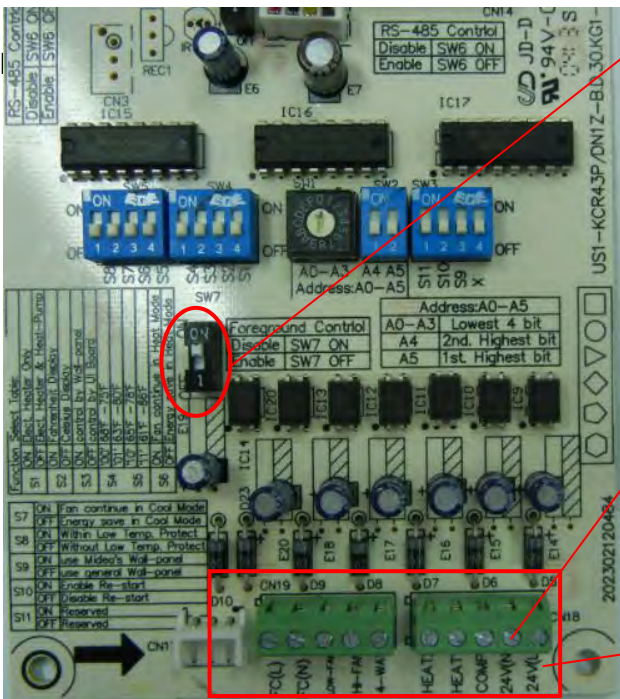

Turn the switch to off
You can connect the front desk switch for two ways.

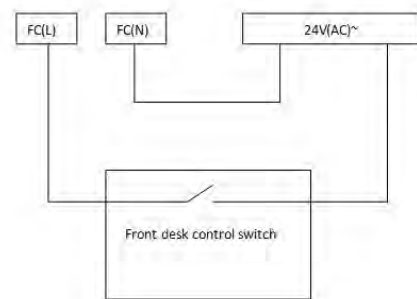
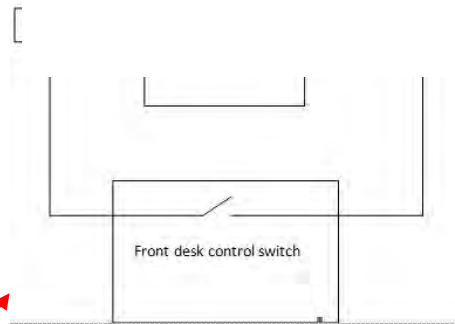

Error codes:

AS- Open or short circuit of room temperature sensor (T1);

ES- Open or short circuit of evaporator temperature sensor(T2);

CS-Open or short circuit of condenser temperature sensor (T3);

oS-Open or short circuit of outside temperature sensor(T4);

HS- Open or short circuit of exhaust temperature sensor(T5 or T6);

E4- Communication malfunction between main control board and display board;

LE- Drive-by-wire controller failure.

NOTE: When error occurs, unplug the unit and plug it back in. If error repeats, call for service.

Other codes:

LO-Room temperature is lower than 0°C/32°F;

HI-Room temperature is higher than 37°C/99°F

FP-Low temperature protection

3. Dimension

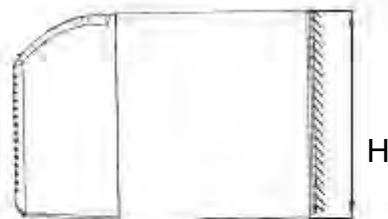
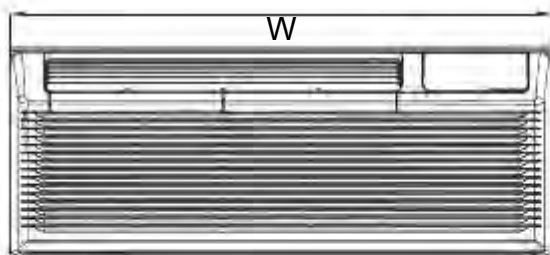
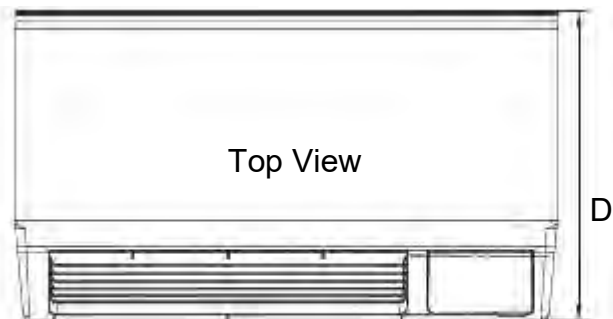

Dimension :	WxHxD (mm)
	WxHxD (inch)
Dimension 1 (no sleeve, rear grille, and rear net)	1067x406x532
	42.0x15.9x20.9
Dimension 2 (no rear grille and rear net, but include sleeve)	1067x408x578
	42.0x16.0x22.8
Dimension 3 (include sleeve and rear net)	1067x408x588
	42.0x16.0x23.1
Dimension 4 (include sleeve, rear net and rear grille)	1067x408x606
	42.0x16.0x23.9

4. Wiring Diagram

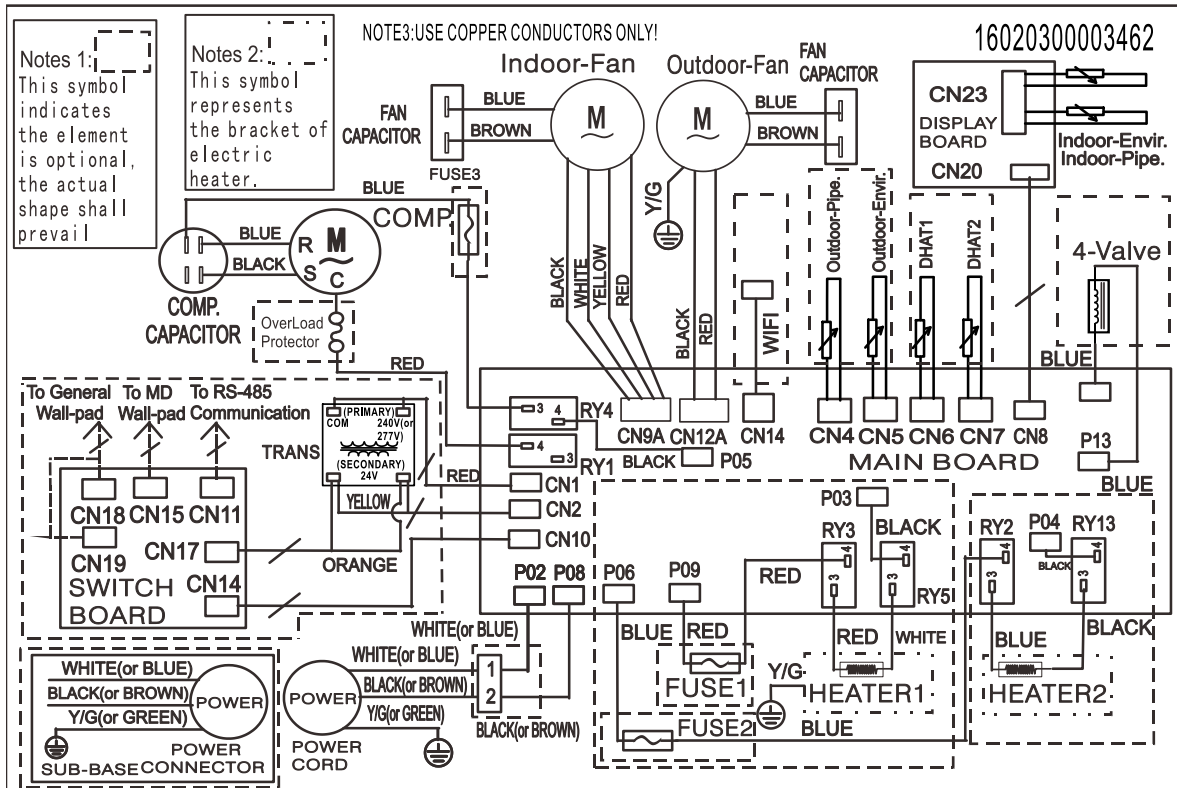

5. Refrigerant Cycle Diagram

The figure below is a brief description of the important components and their function in what is called the refrigerant system.

This will help to understand the refrigeration cycle and the flow of the refrigerant in the Heat Pump Cycle.

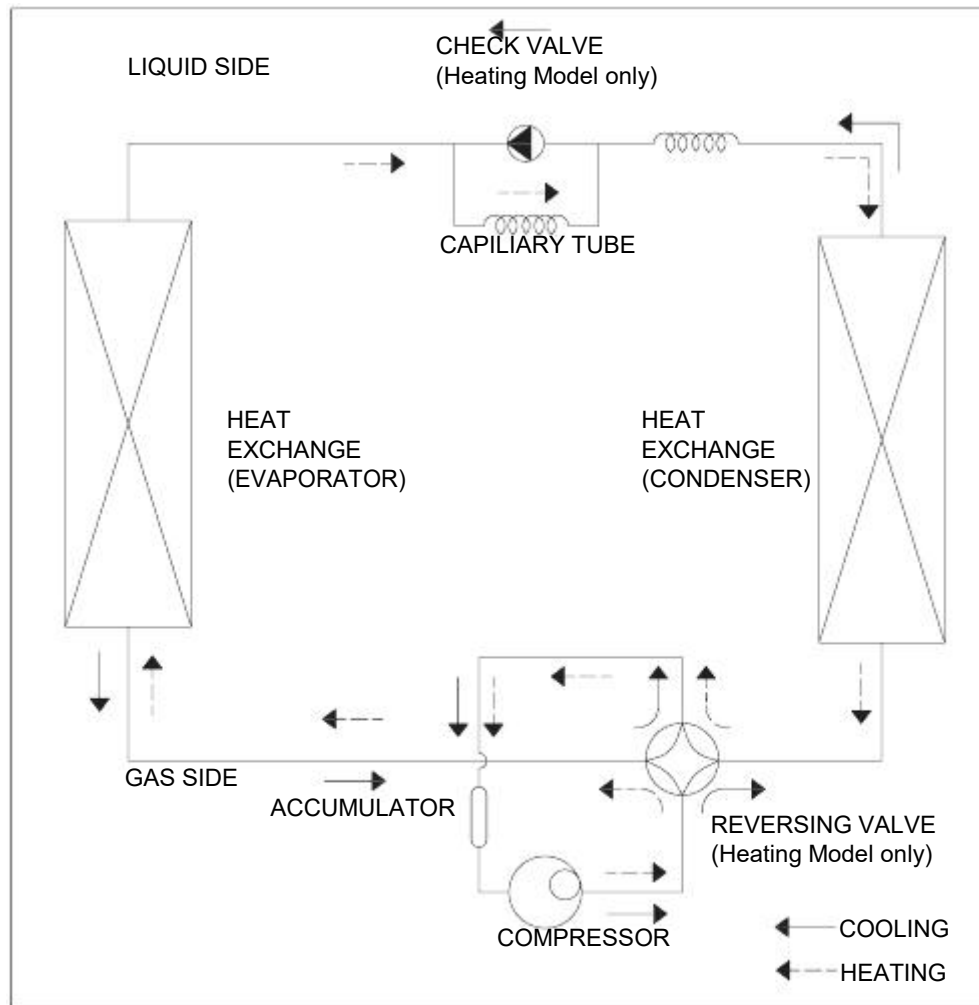

6. Electronic function

6.1 Terms and definitions

TA: Temperature of indoor ambient(T1)

TE: Temperature of evaporator(T2)

TC: Temperature of condenser(T3)

TO: Temperature of outdoor ambient(T4)

TS: The set temperature.

DAHT: Temperature of discharge (T5)

DAHT: Temperature of discharge (T6)

6.2 Electric Control working environment

Input voltage: 230/208V, 60Hz

6.3 Protection function

6.3.1 The compressor functions protection with a delay of three minutes.

6.3.2 Sensor protection at open or short circuit.

6.3.3 Evaporator anti-freezing protection at cooling mode.

6.4 Fan only mode

6.4.1 The temperature can't be controlled at the mode, and the room ambient temperature is display on LED.

6.4.2 The Ion/ Timer functions are valid at the fan-only mode.

6.4.3 Compressor and 4-valve cease operation.

6.5 Cooling mode

6.5.1 The speed of indoor fan can be optionally chosen as High/ Medium /Low.

6.5.2 Operation of outdoor fan motor

Fan motor is on when compressor is on, Fan motor is off when compressor is off. (except the T2 high Temp. protection).

If there's only one speed of the fan motor, use the high speed instead of the low speed.

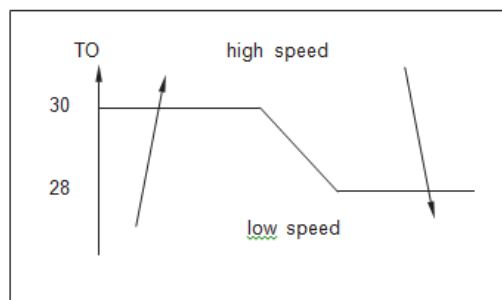

When $TO > 30^{\circ}\text{C}$ and lasts for 1 minute, the fan motor will operate at high speed.

When $TO < 28^{\circ}\text{C}$ and lasts for 1 minute, the fan motor will operate at low speed.

When $28^{\circ}\text{C} \leq TO \leq 30^{\circ}\text{C}$:

A) If fan motor is off originally, it will operate at high speed.

B) If fan motor is on originally, it will keep on working at the original speed.

6.5.3. Compressor Running Guidelines

The compressor will be activated by sensing the difference between setting temperature and the actual ambient room temperature. The compressor operates as below:

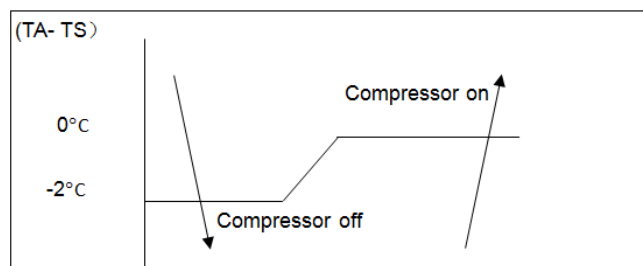

6.5.4 The Ion/ Timer/ Sleep/ Energy Saver/ Follow Me functions are valid at the cooling mode.

6.6 Heating mode

6.6.1 The speed of indoor fan can be optionally chosen as High/ Medium /Low.

6.5.2 Operation of outdoor fan motor

Fan motor is on when compressor is on, Fan motor is off when compressor is off. (except the T2 high Temperature protection).

If there's only one speed of the fan motor, use the high speed instead of the low speed.

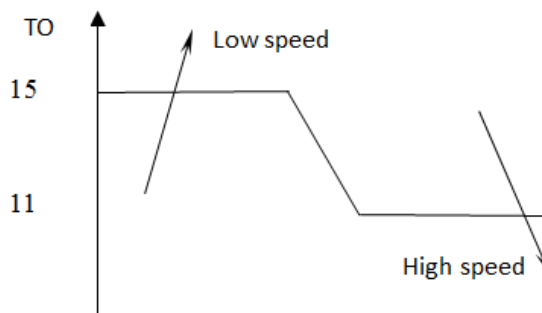

When $TO \geq 15^{\circ}\text{C}$ and lasts for 1 minute, the fan motor will operate at low speed.

When $TO \leq 11^{\circ}\text{C}$ and lasts for 1 minute, the fan motor will operate at high speed.

When $15^{\circ}\text{C} < TO < 11^{\circ}\text{C}$

A) If fan motor is off originally, it will operate at high speed.

B) If fan motor is on originally, it will keep on working at the original speed.

6.6.3. Compressor Running Guidelines

The compressor will be activated by sensing the difference between setting temperature and the actual ambient room temperature.

The compressor operates as below:

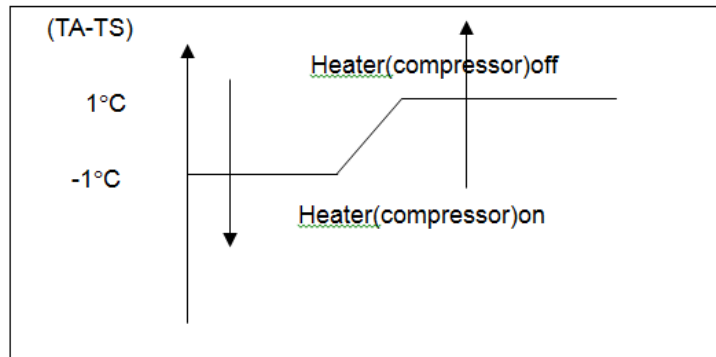

6.6.4 The high temperature protection of evaporator as below:

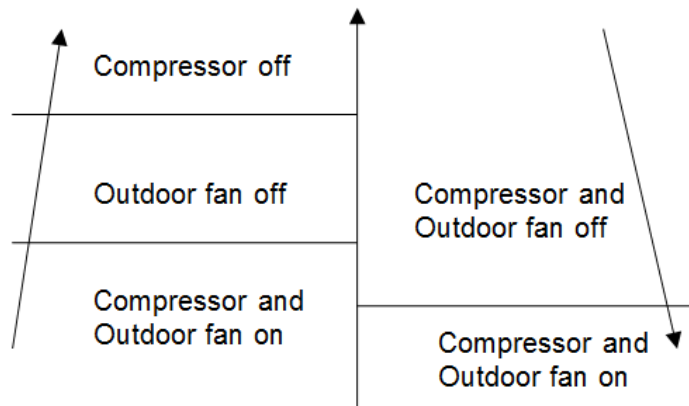

6.6.5 The Electric heater operates as below:

- When $TA < Ts - 1^\circ\text{C}$ (2°F), the fan motor operates, and 3 seconds later, the heater is on and operates at low speed within 30 seconds. After 30 seconds, it changes to the setting speed. If the DAHT temperature checked is higher than the protection temperature, when the heater operating, the fan motor is off automatically.
- When $TA \geq Ts + 1^\circ\text{C}$ (2°F), the heater is off, and the fan motor keeps on working at setting speed. If the DAHT temperature checked is lower than the protection temperature, and the operation time of fan motor is more than 15 seconds, then the fan motor is off. If the T2 protection gets started, the fan motor also does not work.
- If the DAHT temperature checked is higher than the protection temperature, the heater is off and the fan motor keeps on working. Until the DAHT temperature checked is lower than the protection temperature, the heater is on.
- If the DAHT temperature sensor is in open circuit or has short circuited, the heater is off and the fan motor is off 30 seconds later.
- If the ambient temperature sensor is in open circuit or has short circuited, the heater is off and the fan motor keeps on working until the DAHT temperature checked is lower than the protection temperature, the fan motor is off.

6.6.6 The Heat pump operates as below:

The Heat pump's operation mode is in accordance with the way of compressor's working. The compressor is on (electric heater

is off), the fan motor operates according to the anti-cold wind of heat pump. The four-way valve always keeps on. When $TA < Ts - 1^{\circ}\text{C}$ (2°F), the compressor is on, and when $TA \geq Ts + 1^{\circ}\text{C}$ (2°F), it will be off. Before starting the compressor, the indoor fan motor should run for 10 seconds first. TA is not judged within 5 minutes after starting the compressor, but it is judged immediately if the set temperature is changed.

6.7 Dip switches Configurations(Optional)

Note: This Switch board is optional.

-Dip switches controls are located behind front panel, through an opening below the control panel. To access, remove front panel.

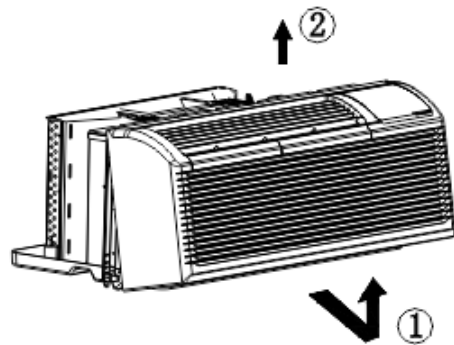

-Dip switches are accessible without opening the control box.

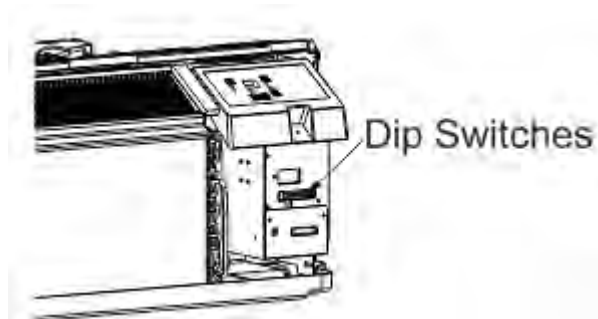

-Unit must be powered OFF to effectively change their status

Dip Switches configurations and functions of each dip switch position as follow figure and table:

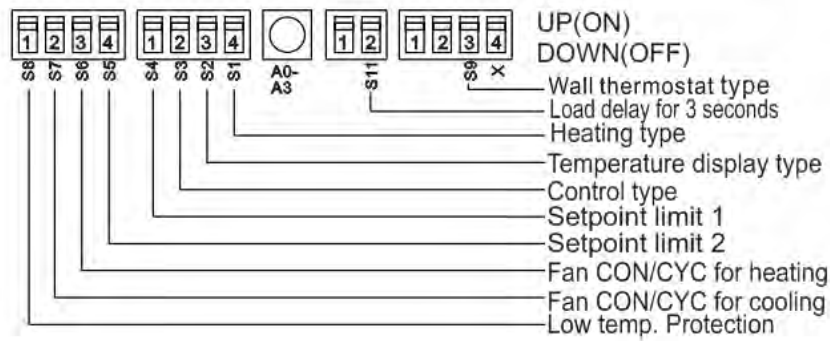

Table 1 DIP SWITCHES CONFIGURATIONS

No.	UP(ON)	DOWN(OFF)	Remarks
S1	Electric Heat Only	Electric Heat and Pump Heat	For Heat Pump unit only
S2	Temperature Display in °C	Temperature Display in °F	
S3	Wall Thermostat Enable	Control Panel Enable	
S4*S5	UP*UP:61°F~86°F (16°C~30°C); UP*DOWN:65°F~78°F (18°C~26°C); DOWN*UP:63°F~80°F (17°C~27°C); DOWN*DOWN:68°F~75°F (20°C~24°C);		Two configurations (S4*S5) combine to select set point range.
S6	Fan Continuous Run for Heating	Fan Cycle for Heating	
S7	Fan Continuous Run for Cooling	Fan Cycle for Cooling	
S8	Low temp. Protection enable	Low temp. Protection disable	
S9(S3 UP)	Use some types of wall Thermostat	Use PTAC other Wall Thermostat	You can consult with the sales agency or manufacturer for details
S9(S3 DOWN)	Use Control Panel only	Use Control Panel or some types of wall Thermostat	Use control Panel or some types of wall Thermostat, the other one must be turned off
SW11	Load delay for 3 seconds	Normal	Optional

NOTE: On heating mode, the setting temperature can't be higher than 29°C/84°F.

*** Electric Heat Only (for heat pump unit only)**

- This setting is typically used for Emergency Heating.

*** Wall Thermostat Enable**

- A wired wall thermostat can be connected to the unit .If it is, this dip switch must be moved to the Wall Thermostat Enable Position, before the wall thermostat will begin control.

*** Set-point Temperature Limits**

- Provides a restricted range of temperature control.

.Heat and Cool Fan CON/CYC Dip-switches

- Allows the fan to operate in continuous or cycle modes while the unit is in heating and cooling mode.

*** Continuous (CON)**

- Allows fan to run continuously, circulating air even when the temperature setting has been satisfied. This switch helps to maintain the room temperature closer to the thermostat setting.

*** Cycle (CYC)**

- This setting allows the fan to cycle on and off with the compressor or electric heater. The fan stops a short time after the temperature setting is satisfied.

6.8 DIP Switches Configurations by Panel Control (Optional)

1. Turn off the unit.

- Press the up (+) and down (-) buttons together for 3 seconds to activate the dip switches configurations by panel control.
- See Table 2 for Dip Switches configurations by panel control.

NOTE: Press the up (+) and down (-) buttons together for 3 seconds again or no operation within 30 seconds to exit the dip switches configurations by panel control and the unit will save the last settings.

- Display function settings with 2 digitals in LED display window, high (left) for dip switches, low (right) for functions.
- Press up (+) button to set the dip switches, press down (-) button to set the functions.

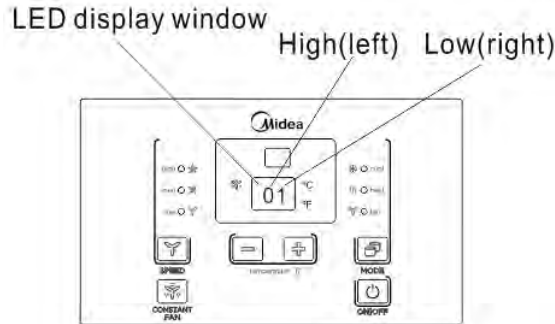

Table 2 DIP SWITCHES CONFIGURATIONS by PANEL CONTROL

No.	High(left)	Low(right)		Remarks
/	0	1-by panel control	0-by dip switches	
S1	1	1-electric heat only	0-electric heat and pump heat	For Heat Pump unit only
S2	2	1-temperature display in °F	0-temperature display in °C	
S3	3	3-use control panel or some types of wall thermostat; 2-use some types of wall thermostat; 1-use PTAC other wall thermostat; 0-control panel enable.		You can consult with the sales agency or manufacturer for details
S4*S5	4	4:62°F~86°F(17°C~30°C); 3:61°F~86°F(16°C~30°C); 2:65°F~78°F(18°C~26°C); 1:63°F~80°F(17°C~27°C); 0:68°F~75°F(20°C~24°C);		
S6	6	1-fan continuous run for heating	0-fan cycle for heating	Not available for "use PTAC other wall thermostat".
S7	7	1-fan continuous run for cooling	0-fan cycle for cooling	
S8	8	1-low temp. protection enable	0-low temp. protection disable	Optional
SW7	A	1-front desk control disable	0-front desk control enable	Optional
SW11	B	1-Load delay for 3 seconds	0-normal	Optional

Note:

1. The LED display window will show "00" when you first enter the setting mode, only when you set "01" you can start the next settings.
2. To activate front desk control function, you need to pull the dip switch SW7 to DOWN(OFF), and then set the Panel control to A0.
3. After all set, press up (+) and down (-) buttons together for 3 seconds to exit the operation interface and cut off the power. When re-power on, the settings are activated.

6.9 Wall Thermostat Terminal (Optional)

IMPORTANT: Only trained, qualified personnel should access electrical panel on unit and install electrical accessories. Please contact your local electrical contractor, dealer, or distributor for assistance.

1. Thermostat Wire Routing

Thermostat wire is field supplied. Recommended wire gauge is 18 to 20 gauge solid thermostat wire.

NOTE: It is recommended that extra wires are run to unit in case any are damaged during installation.

Thermostat wire should always be routed around or under, **NEVER** through, the wall sleeve. The wire should then be routed behind the front panel to the easily accessible terminal connector.

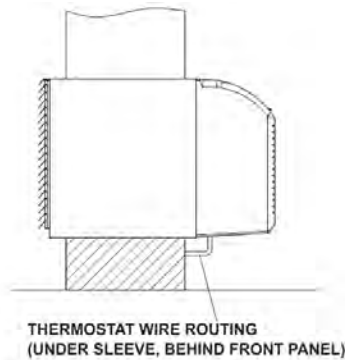
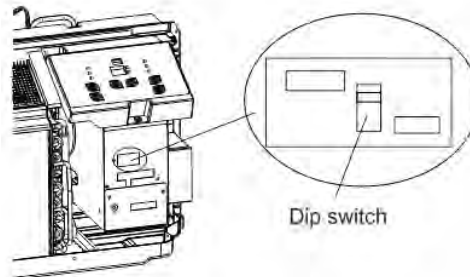

Fig. A - Proper Wire Routing Beneath Unit

NOTE: Refer to thermostat installation instructions for details on installing wall thermostat.

2. Installation instruction of some types of wall Thermostat (you can Consult with the sales agency or manufacturer for details)

- Pull the dip switch to the DOWN(OFF) position as shown below.



- Insert the wire connector of the wall thermostat into the relevant terminal according to different shapes as shown below.

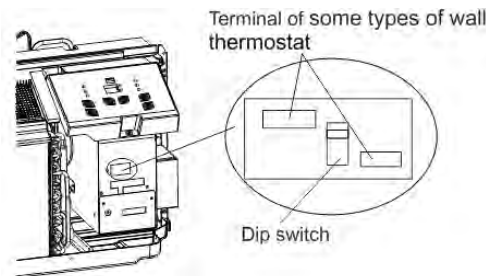

3. Installation instruction of PTAC other Wall Thermostat

- Remove the two screws as shown below and take the cover panel down.

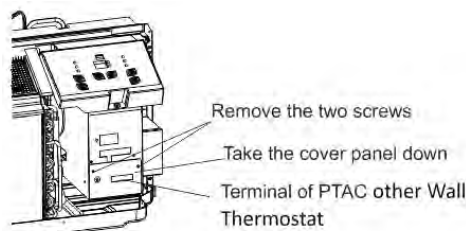

Terminal of PTAC other Wall Thermostat(MODE A)

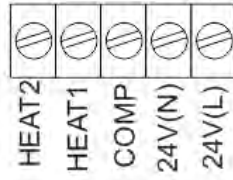
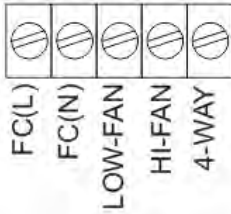

Terminal of PTAC other Wall Thermostat(MODE B)

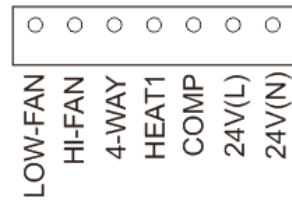

TERMINAL	DESIGNATION
FC(L)	Front desk control terminal L
FC(N)	Front desk control terminal N
LOW-FAN	Low fan speed
HI-FAN	High fan speed
4-WAY	4-way valve; Reverse cycle (Energized in Heat) For heat pump models
HEAT2	Electrical heater 2
HEAT1	Electrical heater 1
COMP	Compressor
24V(N)	24VAC terminal N(Neutral),Common
24V(L)	4VAC terminal L

Caution: UNIT DAMAGE HAZARD

- Failure to follow this caution may result in equipment damage or improper operation.
- Improper wiring may damage unit electronics. Common busing is not permitted. Damage or erratic operation may result.

Note:

- Use terminal 4-way for heat pump connection only.
- Suggest set the compressor protection time more than 3 minutes in wall thermostat. If set less than 3 minutes, the compressor will restart delay 3 minutes still.
- Wall thermostat must be heating changeover 4-way valve.
- For thermostats that have only one fan speed output (on or auto), the fan speed is determined by how the terminal connector is wired. If Low fan is desired, wire the G output from the thermostat to (LOW-FAN) on the units terminal block. If High fan is desired, wire the G output from the thermostat to (HI-FAN) on the units terminal block.
- The range of set temperature of Wall thermostat must be in consonance with the range of DIP switch setting.
- Wall thermostat must be set the type properly in consonance with the unit type : heat pump or no heat pump.
- If the Wall thermostat has only one electrical heater output, connect the two terminals of HEAT 1 and HEAT 2, the unit can operate two electrical heaters(only for the unit has two electrical heaters). Otherwise operate one electrical heater.
- Please do not remove the control panel.

4. FRONT DESK CONTROL

The controller can handle a switch signal from FC(L) and FC(N) input, called front desk control. Input must be 24VAC. If system doesn't receive a 24VAC signal, it will turn unit off; otherwise, the unit runs in normal control.

- The DIP switch can control the FRONT DESK CONTROL feature. The DIP switch is on the DOWN position, the unit will be turn off; otherwise, the unit runs in normal control.

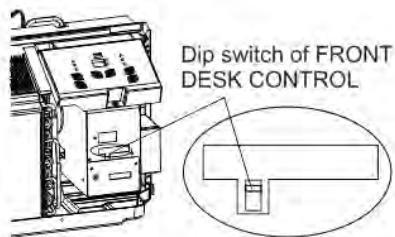

7. Unit components

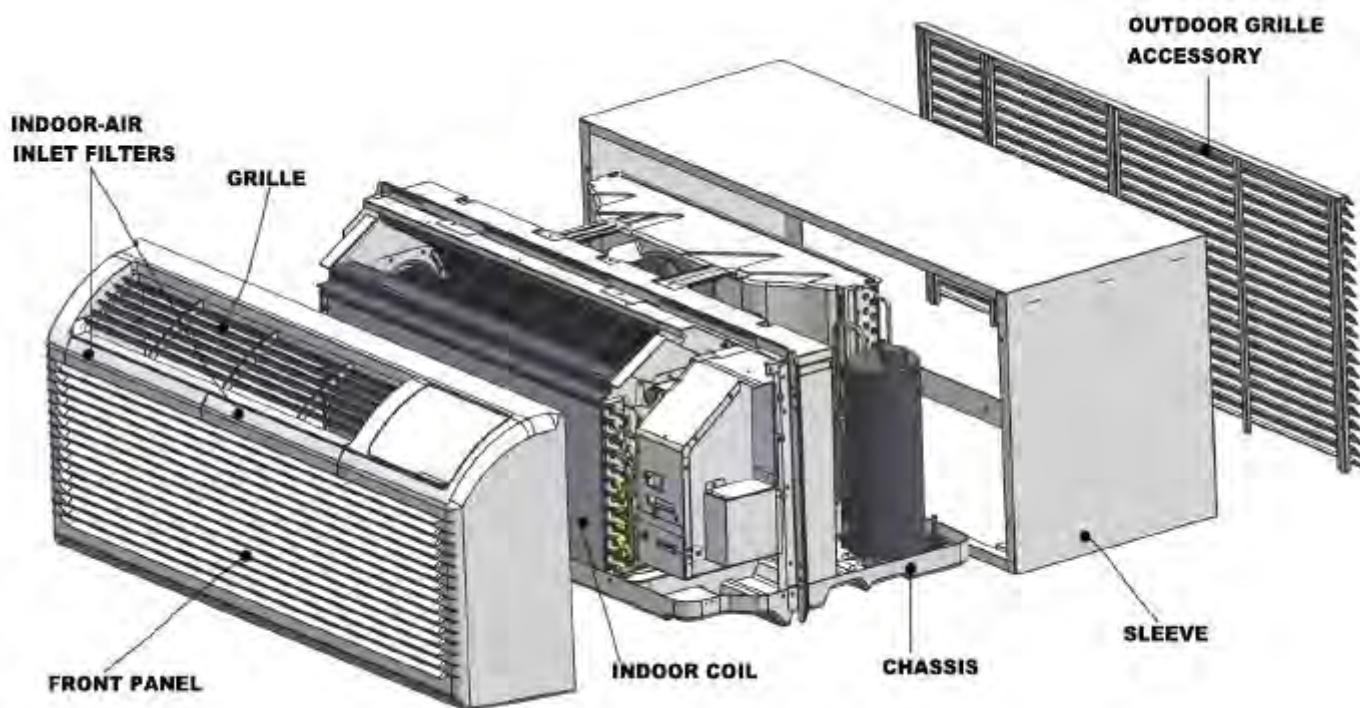

Decomposition figure

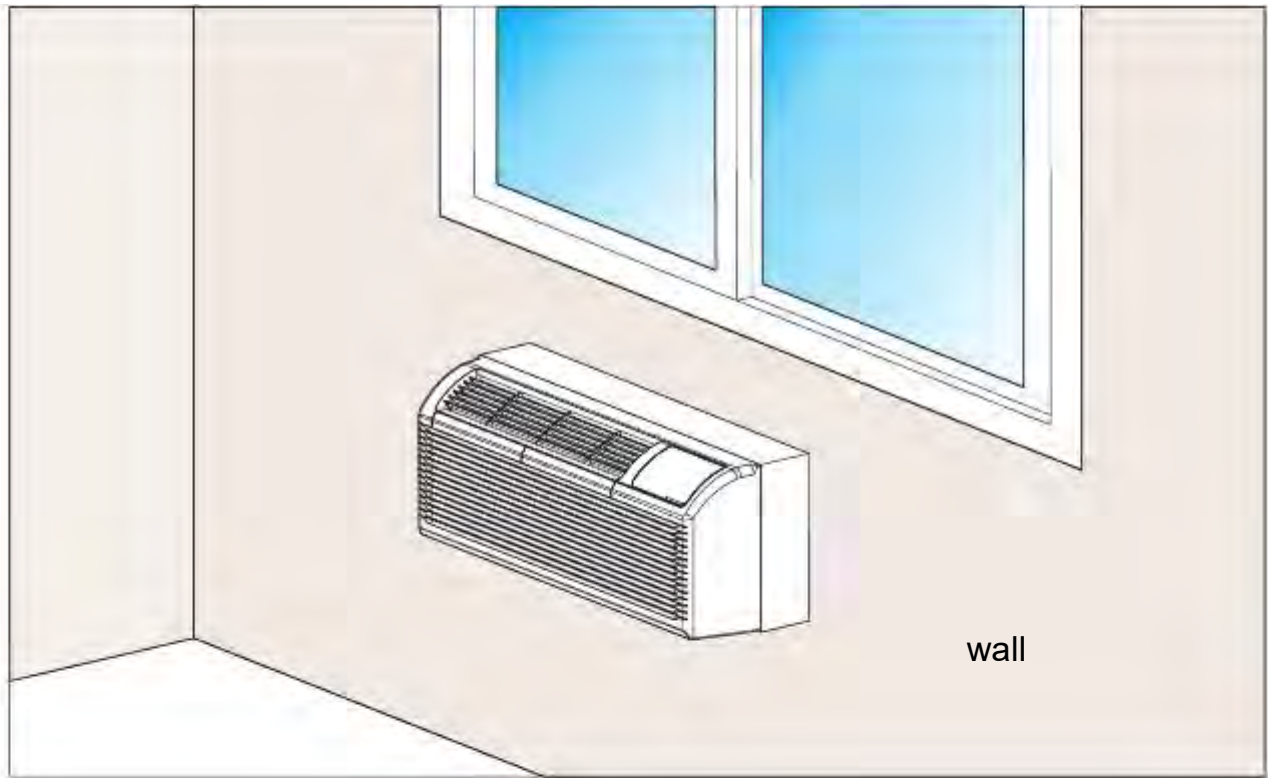

Installation figure

8. Installation details

8.1 How to install the unit

CAUTION

- There are sharp edges that can cause serious cuts.
- When lifting the air conditioner, it is HEAVY. Use 2 people to lift.



- For existing sleeve, you should measure the wall sleeve dimensions.
- Install the new air conditioner according to these installation instructions to achieve the best performance. All wall sleeves used to mount the new air conditioner must be in good structural condition and have a rear grille that securely attaches to the sleeve or the flange of the sleeve to secure the new air conditioner.
- To avoid vibration and noise, make sure the unit is installed securely and firmly.
- When installing the sleeve, make certain there is nothing within 20 of the back that would interfere with heat radiation and exhaust air flow. (See Fig.2)

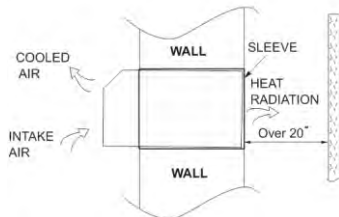

● PREPARATION OF SLEEVE ASSEMBLY(optional)

- Refer to the installation instruction of sleeve assembly for details.

● UNIT INSTALLATION

- Carefully remove shipping tapes from the front panel. (See Fig.3) (See Fig.3)
- Remove the front panel. (See Fig.4)
- Remove the shipping screw from the vent door. (See Fig.5)

● UNIT INSTALLATION (CONTINUED)

- Rotate the vent control lever to either open or close the vent door. (See Fig.6)

NOTE: When vent control lever set at CLOSE, only the air inside the room is circulated and filtered. When set at OPEN, some outdoor air will be drawn into room. This will reduce heating or cooling efficiency.

Dimension of air conditioner

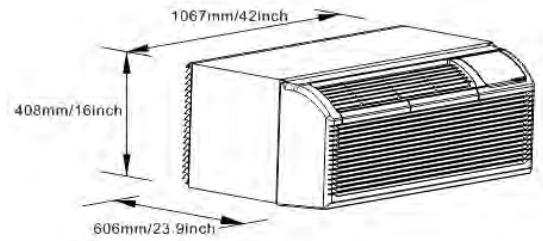

Dimension of sleeve assembly (optional)

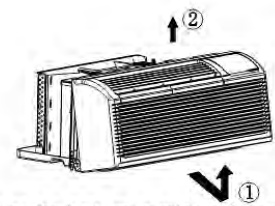
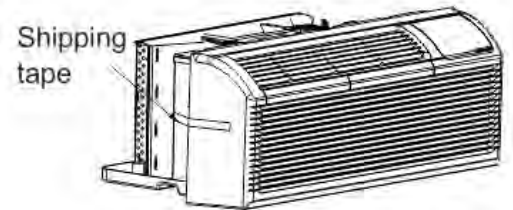
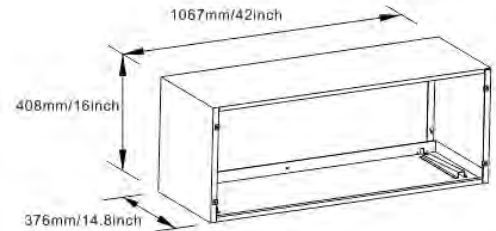

- Pull out at the bottom to release it from the tabs ①.
- Then lift up ②.

Fig.4

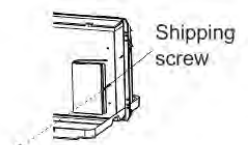

Fig.5

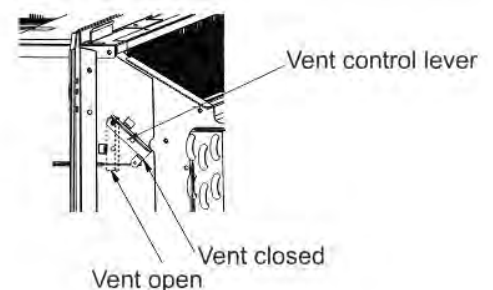
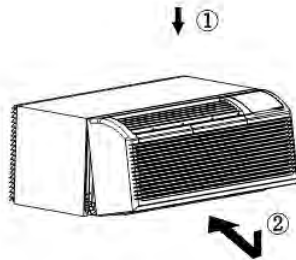

Fig.6

- Lift unit level and slide unit into wall sleeve until firmly against front of wall sleeve and secure with 4 screws and washers (supplied in the SLEEVE ASSEMBLY) through the unit flange holes. (See Fig.7 and Fig.8)
- Reinstall front panel.(See Fig.9)
Place tabs over top rail A . Push Inward at bottom until panel snaps into place B.



Place tabs over top rail ① . Push inward at bottom until panel snaps into place ② .

Fig.9

8.2 Care and cleaning

• FRONT PANEL AND CASE

- Turn unit off and disconnect power supply. To clean, use water and a mild detergent. Do not use bleach and abrasives. Some commercial cleaners may damage the plastic parts.

• OUTDOOR COIL

- Coil on outdoor side of unit should be checked regularly. Unit will need to be removed to inspect dirt build-up that will occur on the inside of the coil. If clogged with dirt and soot ,coil should be professionally cleaned. Clean inside and outside of outdoor coils regularly.

NOTE: Never use a high-pressure spray on coil.

CAUTION

- Do not put obstacles around air-inlet or inside of air-outlet of the unit, such as window curtain etc.
- Always insert the filter securely, clean filter once every two weeks as required.

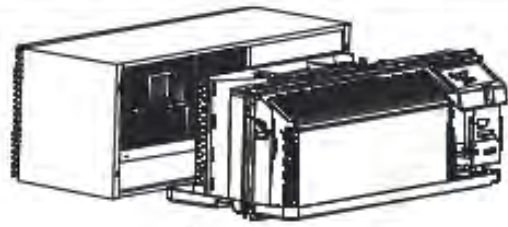

Fig.7

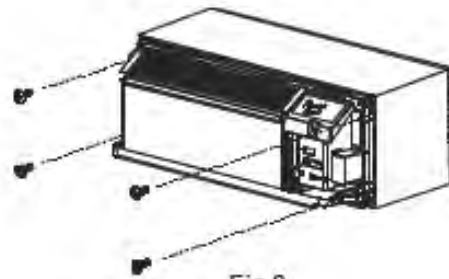

Fig.8

- Removing Air Filter

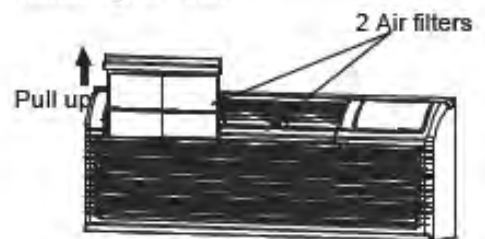

Fig.10

- Replacing Air Filter

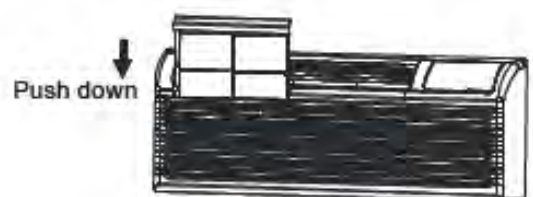

Fig.11



CAUTION

UNIT DAMAGE HAZARD

Failure to follow this caution may result in equipment damage or improper operation.
Airflow restriction may cause damage to the unit.

- The most important thing you can do to maintain unit efficiency is to clean the filters once every two weeks as required.
Clogged filters reduce cooling, heating and airflow.



CAUTION

UNIT DAMAGE HAZARD

Failure to follow this caution may result in equipment damage or improper operation.

- Do not operate unit without filters in place. If a filter becomes torn or damaged, it should be replaced immediately.
- Operating without filters in place or with damaged filter will allow dirt and dust to reach indoor coil and reduce cooling, heating, airflow and efficiency of unit.
Airflow restriction may cause damage to unit.

- The most important thing you can do to maintain unit efficiency is to clean the filters once every two weeks as required.
Clogged filters reduce cooling, heating and airflow.
- **Keeping filters clean will:**
 - Decrease cost of operation.
 - Save energy.
 - Prevent clogged indoor coil.
 - Reduce risk of premature component failure.

VENT DOOR FILTER

IMPORTANT:TURN UNIT OFF BEFORE CLEANING.

- If the vent door is open, access requires the removal of the unit from the wall sleeve. Clean the vent filter twice a year or as required.
- Make sure to remove the shipping screw from the vent door.(See.Fig.5)
- Rotate the vent control lever to open the vent door. (See. Fig.6)
- Remove four screws from the vent door filter. (See.Fig.12)
- First pull out the vent door steel wire from the hole of the vent door, then take off the vent door and filter. (See.Fig.12)
- Clean the filter. Dry thoroughly before placing.
- Replace the vent door and filter, reinstall the four screws.
- Reinsert the vent door steel wire into the hole of the vent door.

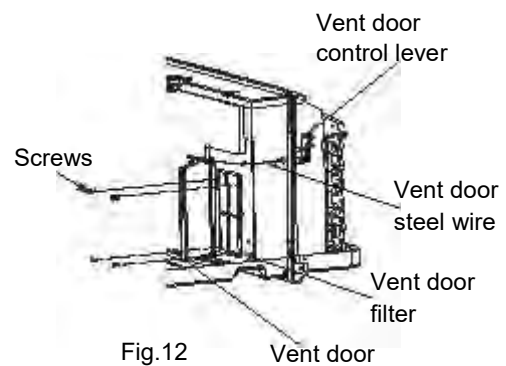

Fig.12

- To Clean Air Filters:

- Vacuum off heavy soil.
- Run water through filter.
- Dry thoroughly before replacing.

9. Operation characteristics

9.1 Cooling operation

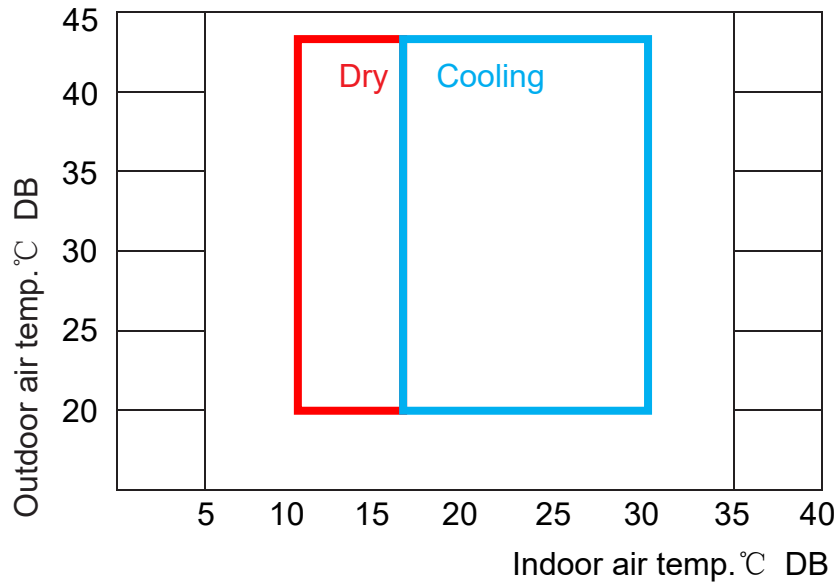

9.2 Heating operation

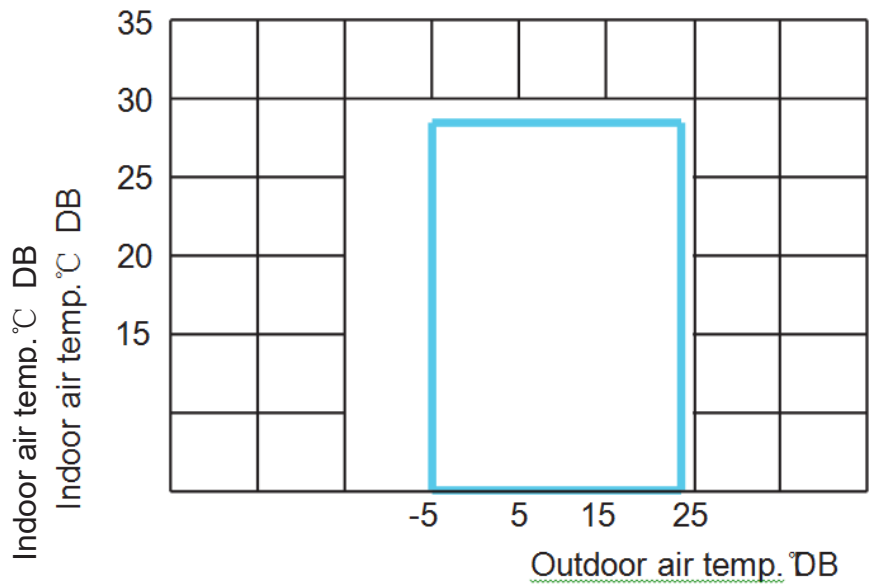

10. Power connection options

Appropriate power cord accessory kit is determined by the voltage, and amperage of the branch circuit. The unit does not come with a power cord (or hard wire kit). An accessory power cord must be ordered to connect the unit to the outlet. If the unit is to be hard wired, an accessory hard wire kit must be ordered.

IMPORTANT:

For 265V units, if a power cord is selected, it must plug into the 265V subbase accessory.

Cord-connected Units



The 240V field supplied outlet must match the plug for the standard 208/230V units and be within reach of the service cord. The standard cord-connected 265V units require an accessory electrical subbase for operation.

Power Cord Protection

The power cord for 230/208v units provide power cord fire protection. Unit power automatically disconnects when unsafe conditions are detected. Power to the unit can be restored by pressing the reset button on plug head. Upon completion of unit installation for 230/208V models, an operational check should be performed using the TEST/RESET buttons on the plug head.

NOTE:

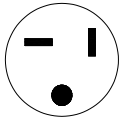
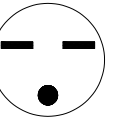
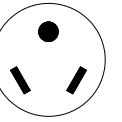
The 265V models do not incorporate this feature as they require use of the electrical subbase accessory. Our sub base accessory is being developed

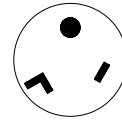
Power Card						
Power Supply	230V,15A	230V,20A	230V,30A	265V,15A	265V,20A	265V,30A

THE APPEARANCE OF POWER PLUG IS DIFFERENT BECAUSE OF DIFFERENT SUPPLIER

PTAC-KC / PTHP-KC POWER CONNECTION

Model Number	POWER SUPPLY KIT CODE	
	20A	30A
	208-230V	208-230V
PTAC09H352-KC	6-20P (20A / 240V)	
PTAC12H352-KC		
PTAC15H352-KC		
PTAC15H502-KC		6-30P (30A / 240V)
PTHP09H352-KC	6-20P (20A / 240V)	
PTHP12H352-KC		
PTHP15H352-KC		
PTHP15H502-KC		6-30P (30A / 240V)

11.Troubleshooting

11.1 Error Display

Codes	Contents
AS	Open or short circuit of T1 temperature sensor
ES	Open or short circuit of T2 temperature sensor
CS	Open or short circuit of T3 temperature sensor
oS	Open or short circuit of T4 temperature sensor
HS	Open or short circuit of T5 or T6 temperature sensor
Lo	Temperature is lower than display range(0°C/32°F)
HI	Temperature is higher than display range(37°C/99°F)
E4	Communication malfunction between main control board and display board.
LE	Drive-by-wire control failure

11.2 Troubleshooting

11.2.1 Open circuit or short circuit of temperature sensor diagnosis and solution(AS/E5/CS/oS/HS)

Error Code	AS/E5/CS/oS/HS
Malfunction decision conditions	If the sampling voltage is lower than 0.06V or higher than 4.94V, the LED will display the failure.
Supposed causes	<ul style="list-style-type: none">● Wiring mistake● Faulty sensor● Faulty PCB

Troubleshooting:

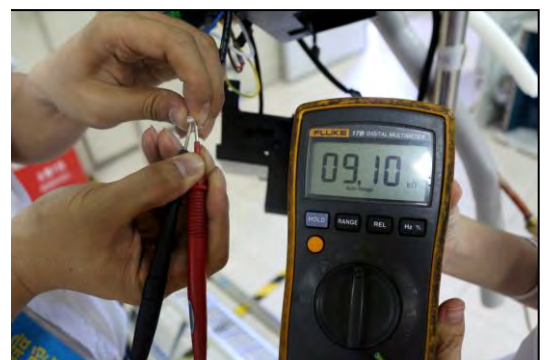
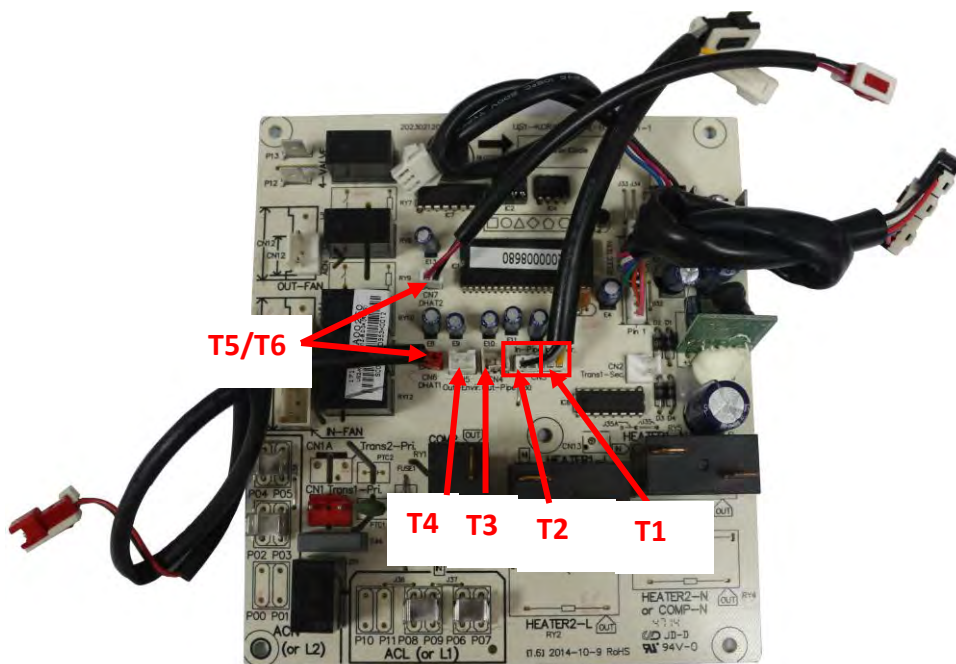
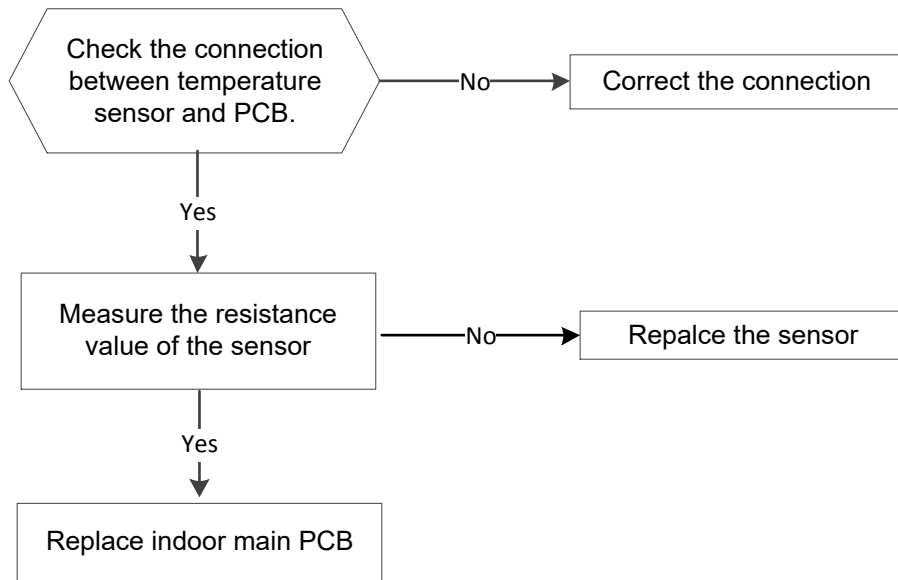

11.2.2 Communication malfunction between main control board and display board. (E4)

Error Code	E4
Malfunction decision conditions	Main control board does not receive feedback from display board during 120 seconds.
Supposed causes	<ul style="list-style-type: none"> ● Wiring mistake ● Faulty display board ● Faulty main control board

Troubleshooting:

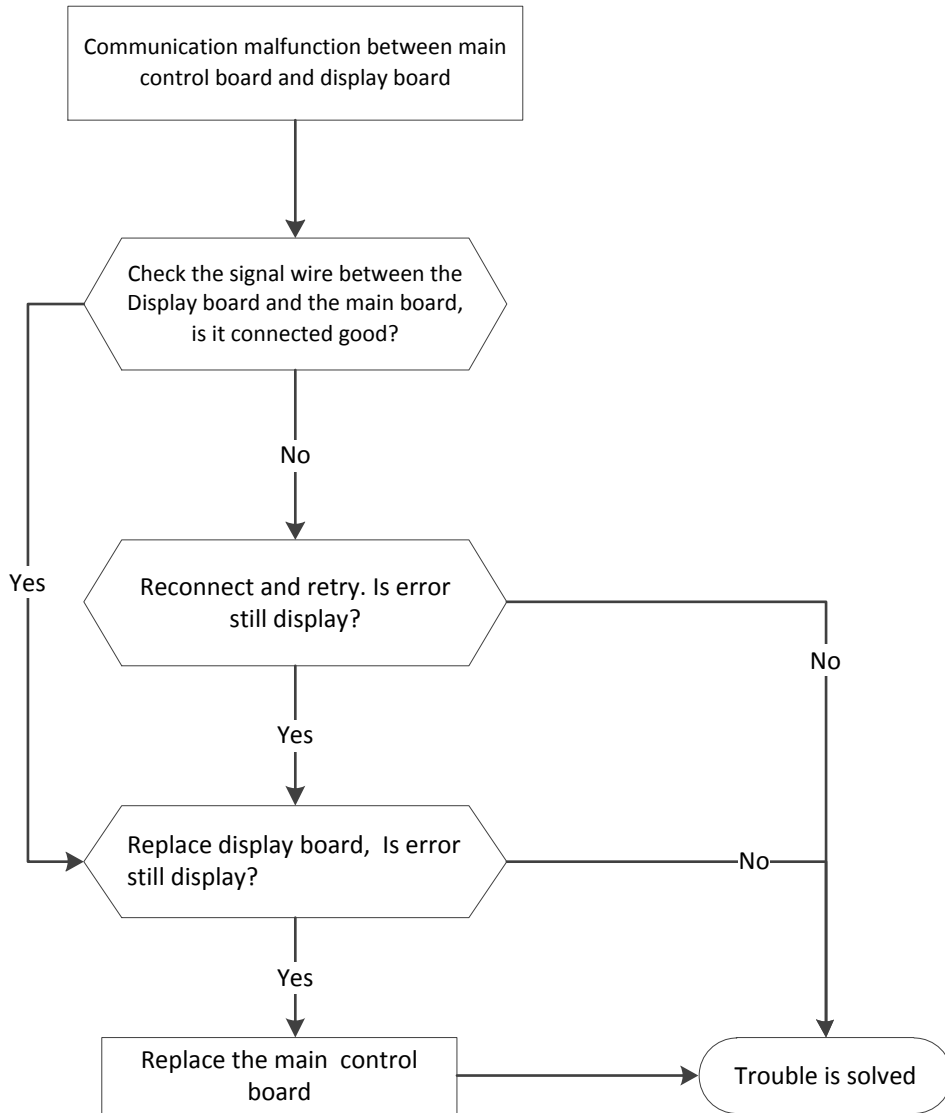

11.2.3 Drive-by-wire controller failure. (LE)

Error Code	LE
Malfunction decision conditions	1, Electric heating signal or compressor signal is on, but fan signal is off 2, Electric heating signal and compressor signal are on, but 4-way valve signal is off 3, Cooling only models have heating signal, or the 4-way valve signal and compressor signal are on at the same time.
Supposed causes	<ul style="list-style-type: none"> ● Wiring mistake ● Faulty wire controller ● Wire controller doesn't match

Troubleshooting:

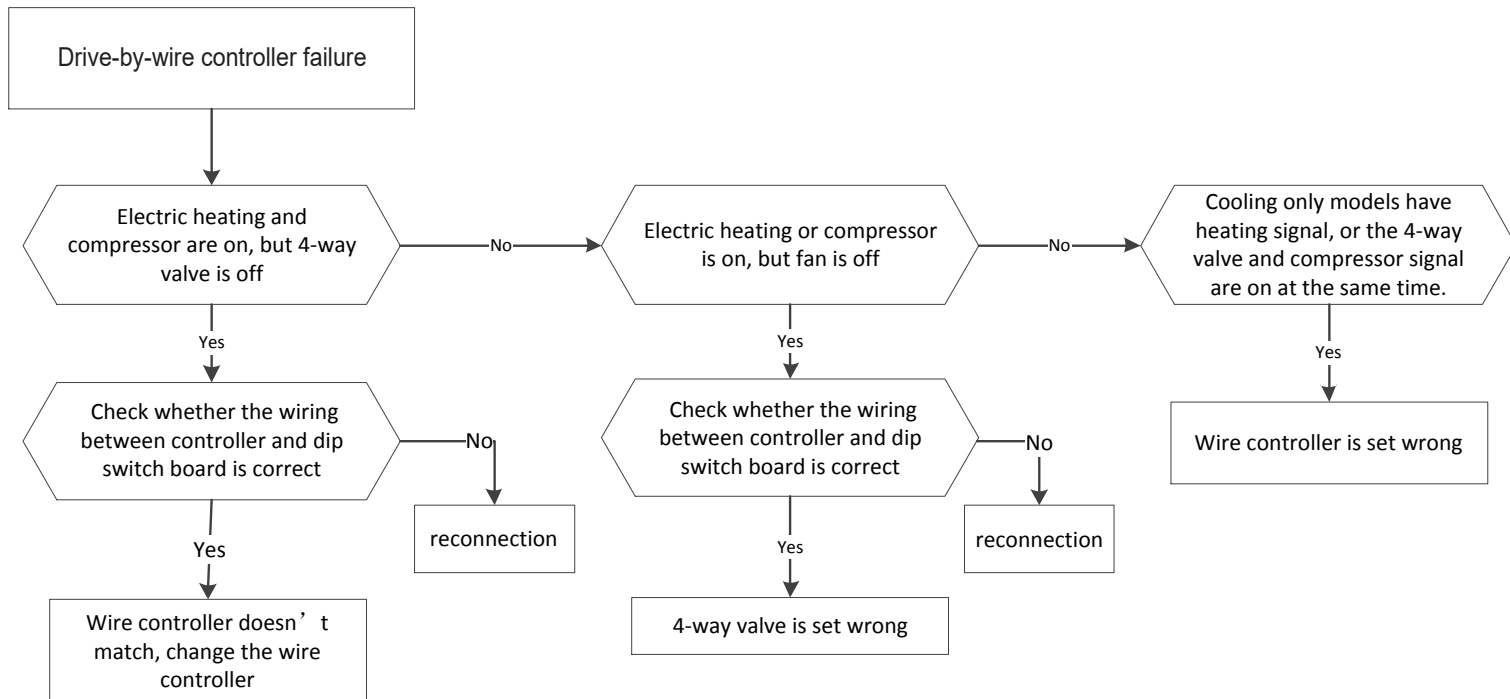

DIP SWITCH TERMINAL	DESIGNATION	24V CONTROLLER
FC(L)	Front desk control terminal L	
FC(N)	Front desk control terminal N	
LOW-FAN	Low fan speed	GL
HI-FAN	High fan speed	GH
4-WAY	4-way valve(for heat pump model)	B
HEAT2	Electrical heater 2	W
HEAT1	Electrical heater 1	(W)
COMP	Compressor	Y
24V(N)	24VAC terminal N COM	C
24V(L)	24VAC terminal L	R

POSSIBLE CAUSES	SOLUTIONS
UNIT DOES NOT START Unit may have become unplugged Fuse may have blown Circuit breaker may have been tripped Unit may be off Unit may be in a protection mode.	Check that plug is plugged securely in wall receptacle. Note: Plug has a test/reset button on it. Make sure that the plug has not tripped. Replace the fuse. See Note 1. Reset circuit breaker. See Note 1. Turn unit on (bottom right button on keypad).
UNIT NOT COOLING/HEATING ROOM Unit air discharge section is blocked Temperature setting is not high or low enough Note: Setpoint limits may not allow the unit to heat or cool the room to the temperature desired. Check section on dipswitch settings. Unit air filters are dirty. Room is excessively hot or cold when unit is started. Vent door left open. Unit may be in a protection mode. Compressor is in time delay.	Make sure that curtains, blinds or furniture are not restricting or blocking unit airflow. Reset to a lower or higher temperature setting. Remove and clean filters. Allow sufficient amount of time for unit to heat or cool the room. Start heating or cooling early before outdoor temperature, cooking heat or gatherings of people make room uncomfortable. Close vent door. Check dipswitch settings for desired comfort. Wait approximately 3 minutes for compressor to start.
DISPLAY HAS STRANGE NUMBERS/CHARACTERS ON IT	The unit may be in a protection mode. The unit may be set for °C (instead of °F).
UNIT MAKING NOISES	Clicking, gurgling and whooshing noises are normal during operation of unit.
WATER DRIPPING OUTSIDE	If a drain kit has not been installed, condensation runoff during very hot and humid weather is normal. See Note 2. If a drain kit has been installed and is connected to a drain system, check gaskets and fittings around drain for leaks and plugs.
WATER DRIPPING INSIDE Wall sleeve is not installed level	Wall sleeve must be installed level for proper drainage of condensation. Check that installation is level and make any necessary adjustments.
ICE OR FROST FORMS ON INDOOR COIL Low outdoor temperature Dirty filters	When outdoor temperature is approximately 55°F or below, frost may form on the indoor coil when unit is in Cooling mode. Switch unit to FAN operation until ice or frost melts. Remove and clean filters.
COMPRESSOR PROTECTION Power may have cycled, so compressor is in a restart protection.	Random Compressor restart -Whenever the unit is plugged in, or power has been restarted, a random compressor restart will occur. After a power outage, the compressor will restart after approximately 3 minutes. Compressor Protection -To prevent short cycling of the compressor, there is a random startup delay of 3 minutes and a minimum compressor run time of 3 minutes.
ELECTRIC HEATING FAILURE	Clean the evaporator once every three months by professional people.

NOTES:

1. If circuit breaker is tripped or fuse is blown more than once, contact a qualified electrician.
2. If unit is installed where condensation drainage could drip in an undesirable location, an accessory drain kit should be installed and connected to drain system.

Characteristic of temperature sensor

Temp. °C/°F	Resistance KΩ	Temp. °C/°F	Resistance KΩ	Temp. °C/°F	Resistance KΩ
-10/14	62.2756	17/62	14.6181	44/111	4.3874
-9 /15.8	58.7079	18/64	13.918	45/113	4.2126
-8 /17.6	56.3694	19/66	13.2631	46/115	4.0459
-7 /19.4	52.2438	20/68	12.6431	47/117	3.8867
-6 /21.2	49.3161	21/70	12.0561	48/118	3.7348
-5 /23	46.5725	22/72	11.5	49/120	3.5896
-4 /24.8	44	23/73	10.9731	50/122	3.451
-3 / 26.6	41.5878	24/75	10.4736	51/124	3.3185
-2 / 28.4	39.8239	25/77	10	52/126	3.1918
-1 /30.2	37.1988	26/79	9.5507	53/127	3.0707
0 /32	35.2024	27/81	9.1245	54/129	2.959
1 /33.8	33.3269	28/82	8.7198	55/131	2.8442
2 /35.6	31.5635	29/84	8.3357	56/133	2.7382
3 /37.4	29.9058	30/86	7.9708	57/135	2.6368
4 /39.2	28.3459	31/88	7.6241	58/136	2.5397
5 /41	26.8778	32/90	7.2946	59/138	2.4468
6 /42.8	25.4954	33/91	6.9814	60/140	2.3577
7 /44.6	24.1932	34/93	6.6835	61/142	2.2725
8 /46.4	22.5662	35/95	6.4002	62/144	2.1907
9 /48.2	21.8094	36/97	6.1306	63/145	2.1124
10 /50	20.7184	37/99	5.8736	64/147	2.0373
11 /51.8	19.6891	38/100	5.6296	65/149	1.9653
12 /53.6	18.7177	39/102	5.3969	66/151	1.8963
13 /55.4	17.8005	40/104	5.1752	67/153	1.830
14 /57.2	16.9341	41/106	4.9639	68/154	1.7665
15 /59	16.1156	42/108	4.7625	69/156	1.7055
16 /60.8	15.3418	43/109	4.5705	70/158	1.6469

KLIMAIRE[®] ≈

The Klimate logo is a registered Trademark of Klimate Products inc.

Copyright 2020 Klimate Products Inc.

2190 NW 89 Place, Doral, FL 33172 - USA

Tel: (305)594-4972

Fax (305) 675-2212

www.klimate.com

sales@klimate.com